

## About HDD Mode of DVD-MovieAlbumSE

DVD-MovieAlbumSE provides the HDD mode that allows you to play back and edit DVD-VR format video exported in the hard drive on PC by DVD-MovieAlbum CopyTool.

### Step

1. Insert a DVD-RAM that you want to edit into the DVDCAM, and then connect the DVDCAM into the USB port on PC, as shown in the figure below.

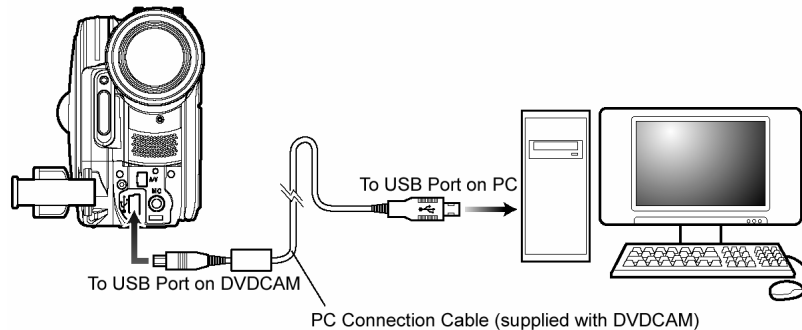

2. Turn the DVDCAM power switch to the video position.
3. Start DVD-MovieAlbumSE, and then click the **HDD** button.



4. At the initial start, the **HDD folder selection** dialog box appears automatically and shows thumbnails of VR format data currently registered. Select a thumbnail of images that you want to play back or edit, and then click **OK**.

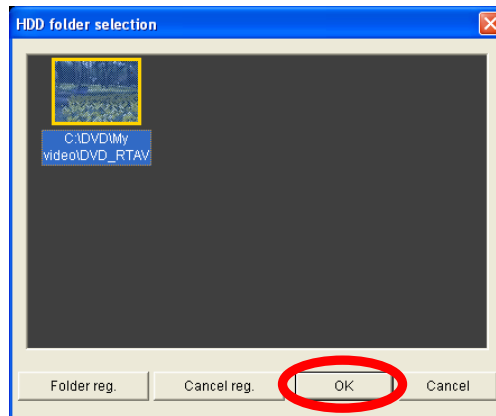

**HDD folder selection Dialog Box**

**Tip**

- 1) If you want to select VR format images not registered in the **HDD folder selection** dialog box, click the **Folder reg.** button, select a folder that contains the VR format images in the hard drive, and then click **OK**. You can register up to 100 folders.

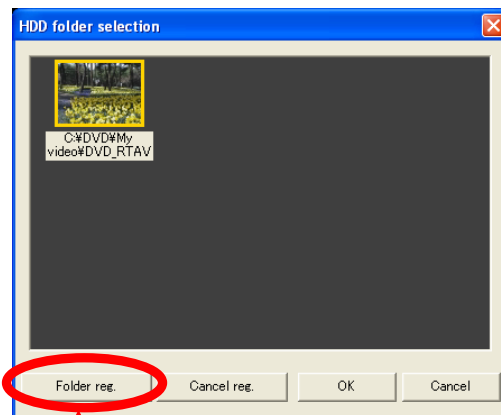

Click the **Folder reg.** button

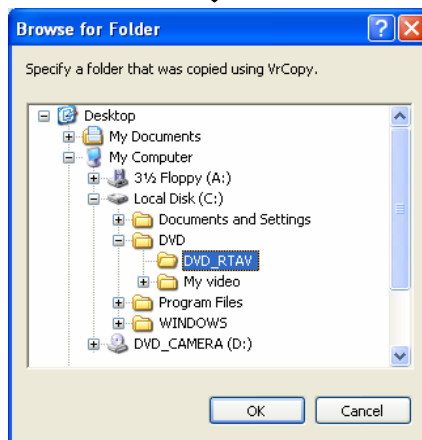

**Browse for Folder Dialog Box**

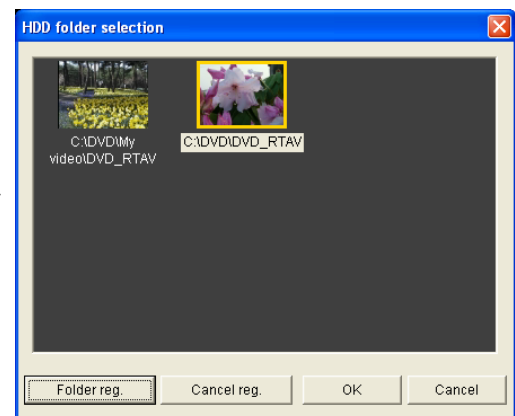

**When a Folder Was Registered**

- 2) To cancel a registered image folder from the **HDD folder selection** dialog box, select the thumbnail to be removed, and then click the **Cancel reg.** button. This procedure cancels the folder selection register only, not actually deleting the VR format data from the hard drive.

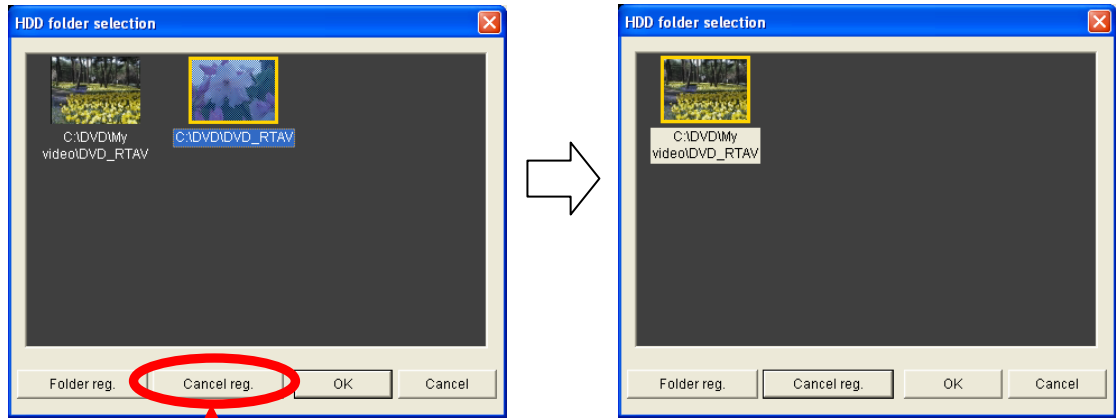

Click the **Cancel reg.** button

- 3) To change a folder in the hard drive, click the **Change folder** button, select a thumbnail of the VR format data in the hard drive in the **HDD folder selection** dialog box, and then click **OK**.

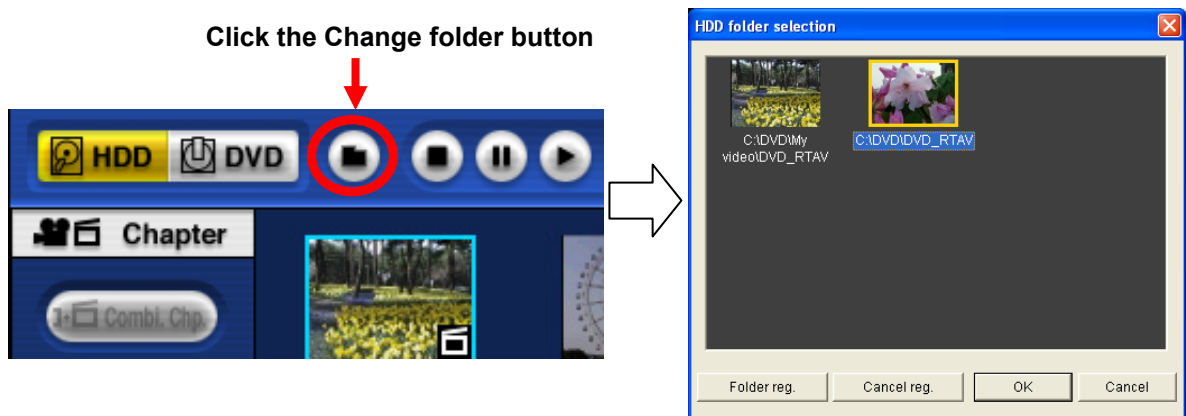

**HDD folder selection Dialog Box**

**Note**

- 1) Data copied into the hard drive using DVD-MovieAlbum CopyTool only can be used in the HDD mode. Data copied by Explore cannot be used.
- 2) The HDD mode allows you to use the editing functions including creating chapters, dividing a title, and exporting images and playback function, other than the following functions that are available only in the DVD mode:
  - Importing image files on PC
  - Deleting titles and all
  - Entering 3D titles
  - Deleting chapters from a title
  - Deleting and adding files in the Picture mode (also deleting and adding folders)
  - Capturing DV-format video